

Cable	Ø	R min.
4x1.5	8.6	103
4x2.5	10.8	130
4x4	12.2	147
4x6	14	168
4x10	17.6	211

Cable output length 2m:
 Power :
 One shielded class 6 cable coded
 1,2,3 green/yellow
 Thermal sensors :
 One shielded class 6 cable (2x2x0.25mm²)
 Brown-White : PTC
 Green-Yellow : KTY84
 Minimum bending radius
 (except for the first 50mm) :
 See Table

ZONE FREE OF ANY PART
 (cable passing)
 NO STRESS, NO BENDING, IN THIS AREA

2 series of 12 equidistant holes M8
 One serie on each rotor face
 Angularly aligned series

2 series of 12 equidistant holes M8
 One serie on each stator face
 Angularly aligned series

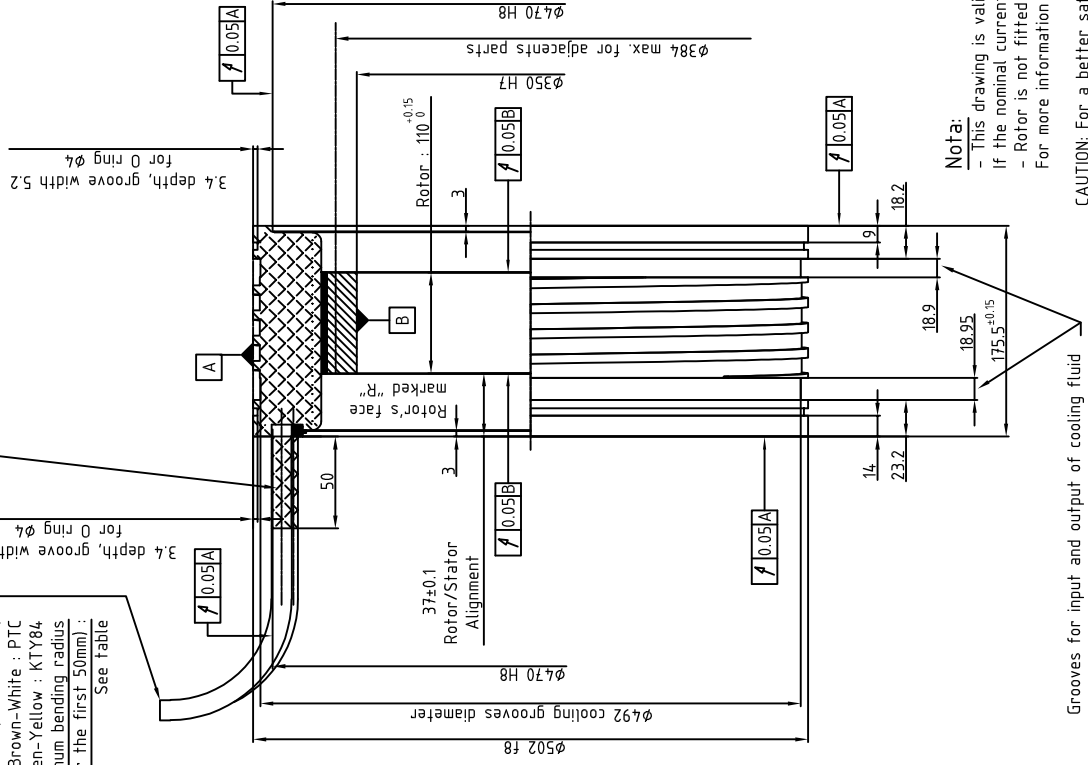
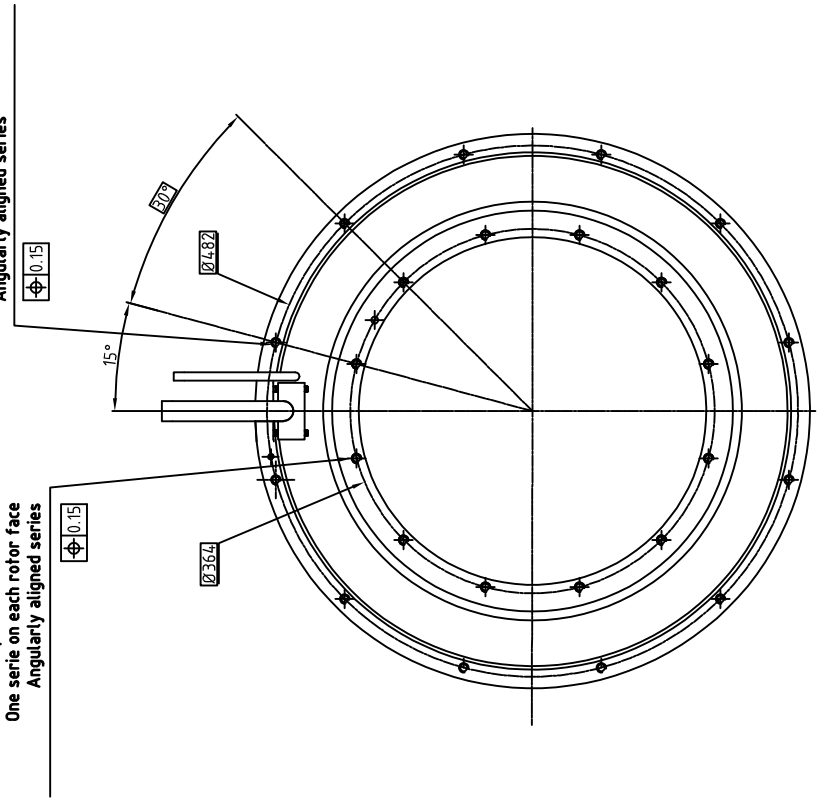

Nota:
 - This drawing is valid only for motors with nominal current lower than 53 Amps.
 - If the nominal current is greater than 53 Amps, please contact us.
 - Rotor is not fitted in the stator
 For more information about mounting see document 500STK0-WA002

Grooves for input and output of cooling fluid
 Inlet and outlet must be opposite to the power cable

CAUTION: For a better safety, it is recommended that the cooling fluid inlet would be made through the hose located on the side opposed to the cabling, while the cooling fluid outlet will be made by the one located on the cable side.

ALXION
 AUTOMATIQUE & PRODUCTIQUE
 Parc Technologique des Fossés Jean
 92712 COLOMBEES Cedex
 Tél: 0141306304 - Fax: 0141306136

500STK4M2XXXXXX