

Cable output length 2m:

- Power: One shielded class 6 cable coded 1,2,3 green/yellow
- Thermal sensors: One shielded class 6 cable (2x2x0.25mm²)
- Brown-White : PTC
- Green-Yellow : KTY84
- Minimum bending radius (except for the first 50mm): See table

Cable	Ø	R min.
4x1.5	8.6	103
4x2.5	10.8	130
4x4	12.2	147
4x6	14	168
4x10	17.6	211

ZONE FREE OF ANY PART
(cable passing)
NO STRESS, NO BENDING, IN THIS AREA.

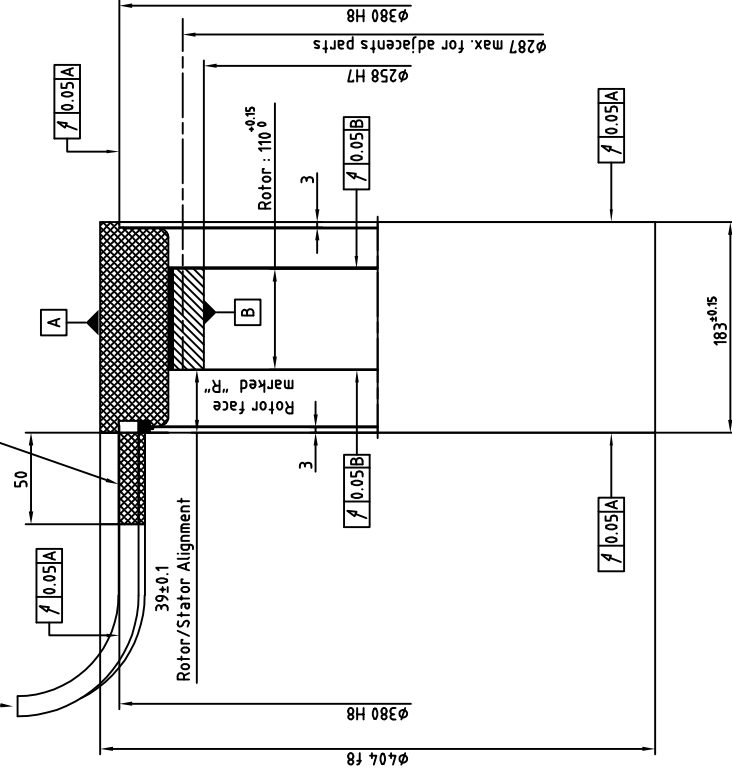

2 series of 12 equidistant holes M6
One serie on each stator face
Angularly aligned series

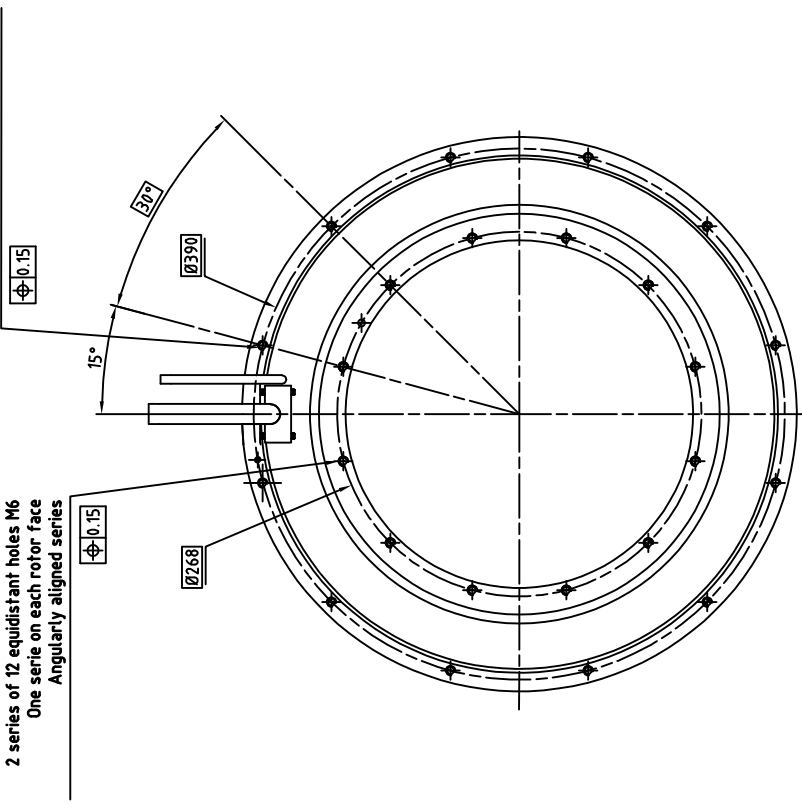

2 series of 12 equidistant holes M6
One serie on each rotor face
Angularly aligned series

Nota:
- This drawing is valid only for motors with nominal current lower than 53 Amps.
- If the nominal current is greater than 53 Amps, please contact us.
- Rotor is not fitted in the stator
For more information about mounting see document 400STK0-WA002

ALXION
AUTOMATIQUE & PRODUCTIQUE
Parc Technologique des Fossés Jean
92712 COLOMBEES Cedex
Tél: 014-1306304 - Fax: 014-1306136

400STK4M1XXXXXX