

Cable output length 2m:

- Power:
 One shielded class 6 cable coded 1,2,3 green/yellow square section and diameter depending of current see table
 Thermal sensors:
 One shielded class 6 cable (2x2x0.25mm²) overall ϕ 7
 Brown-White : PTC
 Green-Yellow : KTY84
 Minimum bending radius (except for the first 50mm):
 See table

Cable	ϕ	R min.
4x1.5	8.6	103
4x2.5	10.8	130
4x4	12.2	147
4x6	14	168
4x10	17.6	211

ZONE FREE OF ANY PART
 (cable passing)
 NO STRESS, NO BENDING, IN THIS AREA.

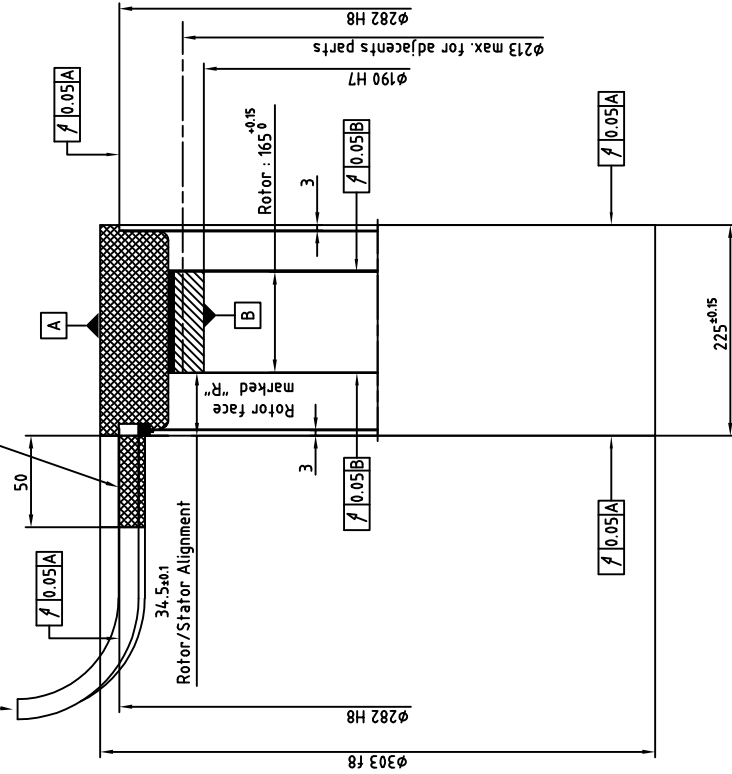

2 series of 12 equidistant holes M5x12
 One serie on each stator face
 Angularly aligned series

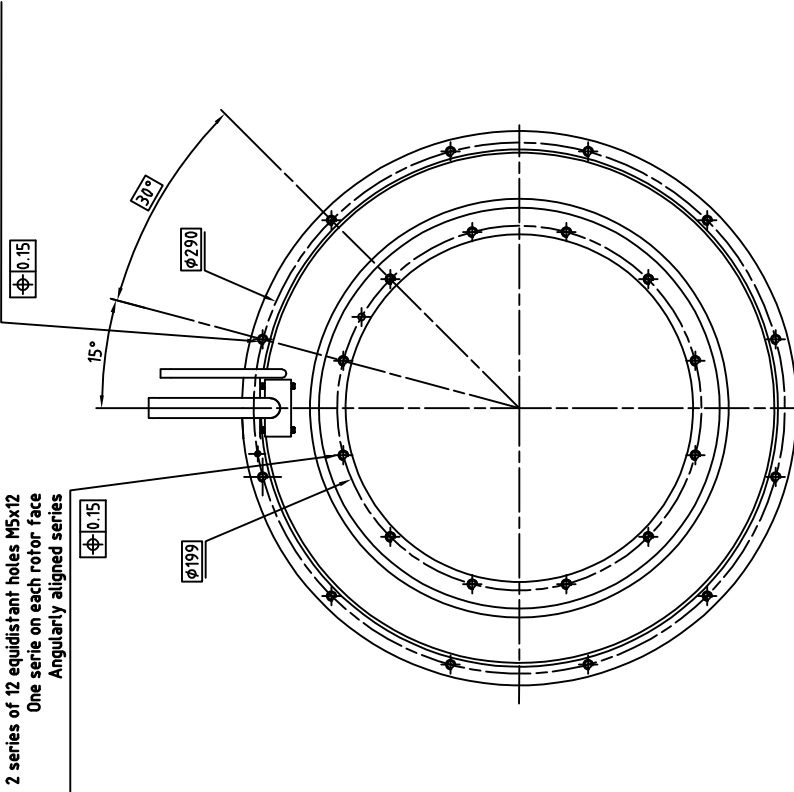

2 series of 12 equidistant holes M5x12
 One serie on each rotor face
 Angularly aligned series

NOTA:
 Rotor is not fitted in the stator
 For more information about mounting see
 document 300STK0-WA002

ALXION
 AUTOMATIQUE & PRODUCTIQUE
 Parc Technologique des Fossés Jean
 92712 COLOMBEES Cedex
 Tél: 014-1306304 - Fax: 014-1306136

300ATK6M1XXXXXX