

Power cable diameter and section depends on rated current  
 U : Phase 1  
 V : Phase 2  
 W : Phase 3  
 Green/Yellow : Ground

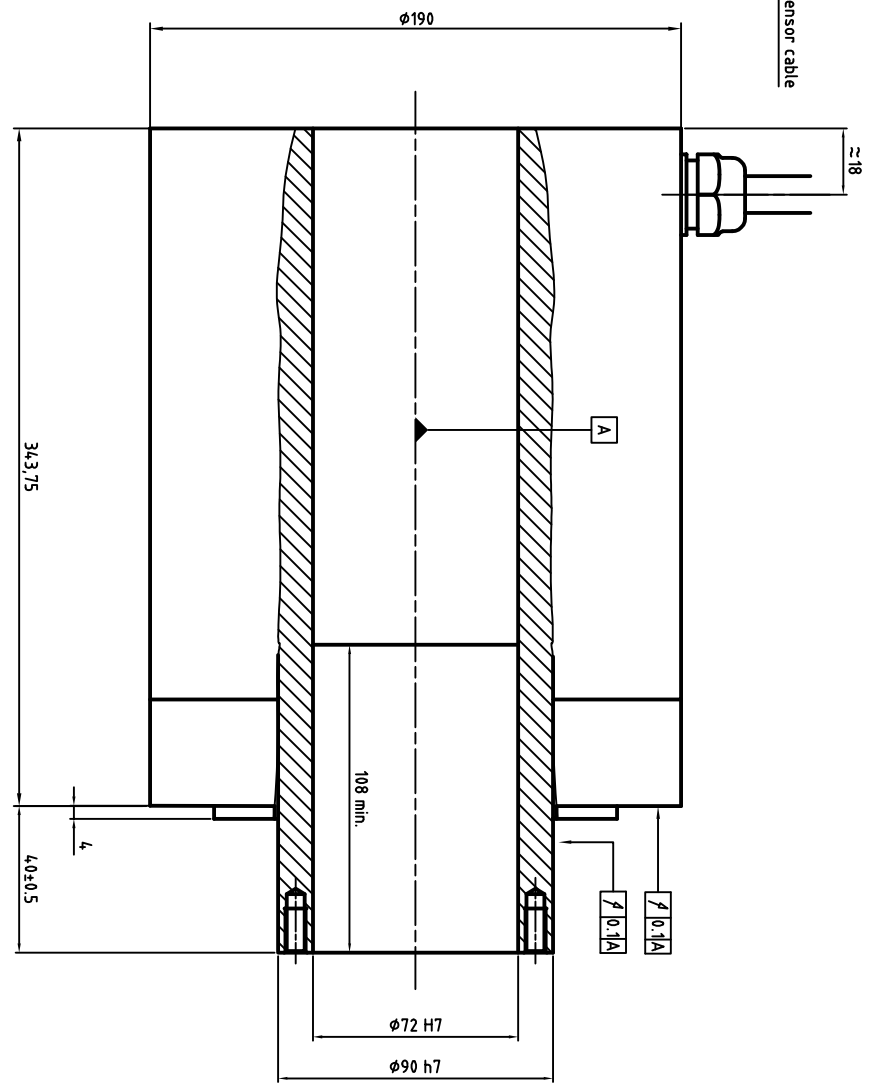
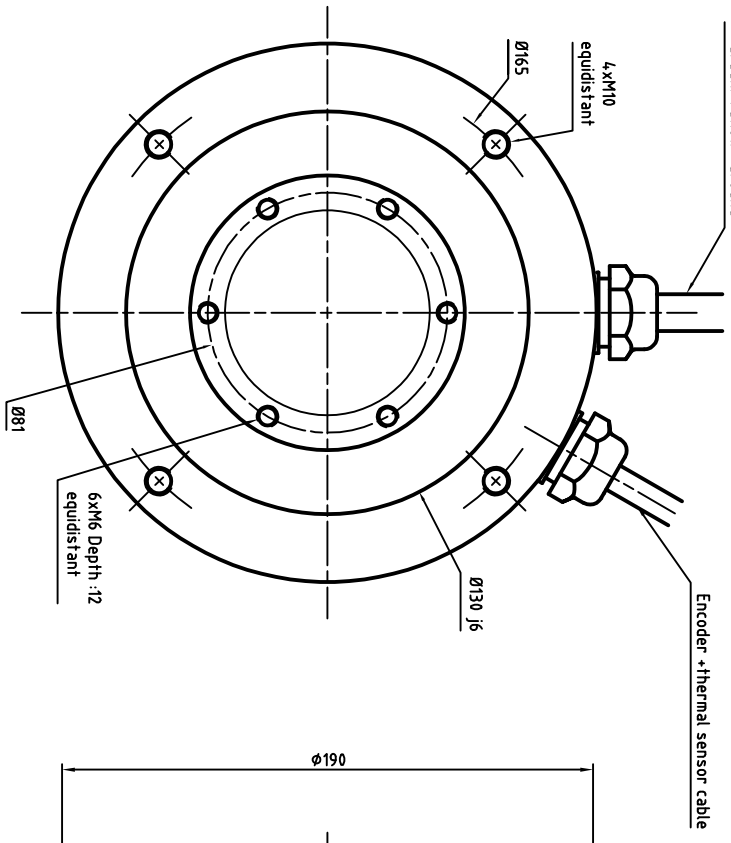

ENCODER SIGNAL COLORS

Cable information	RESOLVER (I)	ECl 4,010 (E)	EBl 4,010 (F)
White	Cosinus + (S1)	CLOCK+	CLOCK+
Brown	Cosinus - (S3)	CLOCK-	CLOCK-
Green	Sinus + (S2)	Up	Up
Yellow	Sinus - (S4)	0V	0V
Pink	PTC	PTC	PTC
Grey	PTC	PTC	PTC
Blue	0V (R3)	DATA+	DATA+
Red	V ref (R1)	DATA-	DATA-
Black	KTY84	KTY84	KTY84
Violet	KTY84	KTY84	KTY84

**ALXION**

AUTOMATIQUE & PRODUCTIQUE  
 Parc Technologique des Fossés Jean  
 92712 COLOMBEES Cedex  
 Tél: 014.1306304 - Fax: 014.1306136

190ST5M11[1-E-F]BXXXXX