

Power cable diameter and section depends on rated current
 U : Phase 1
 V : Phase 2
 W : Phase 3
 Green/Yellow : Ground

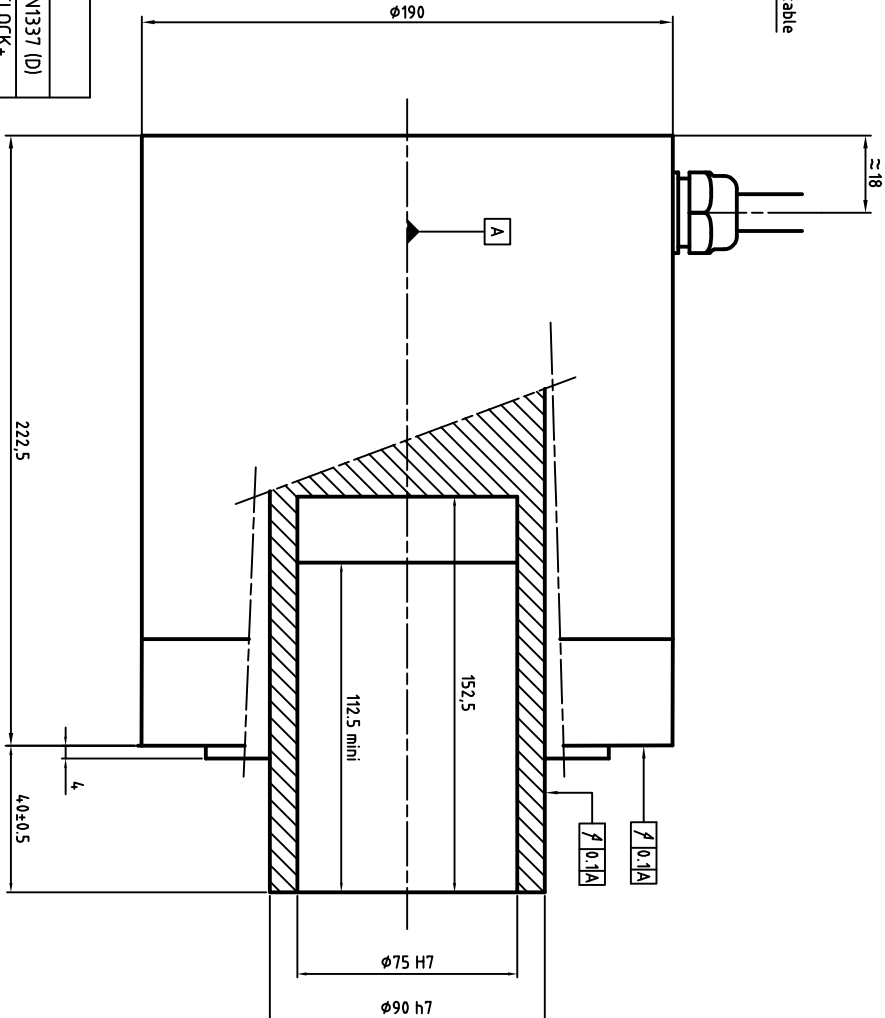
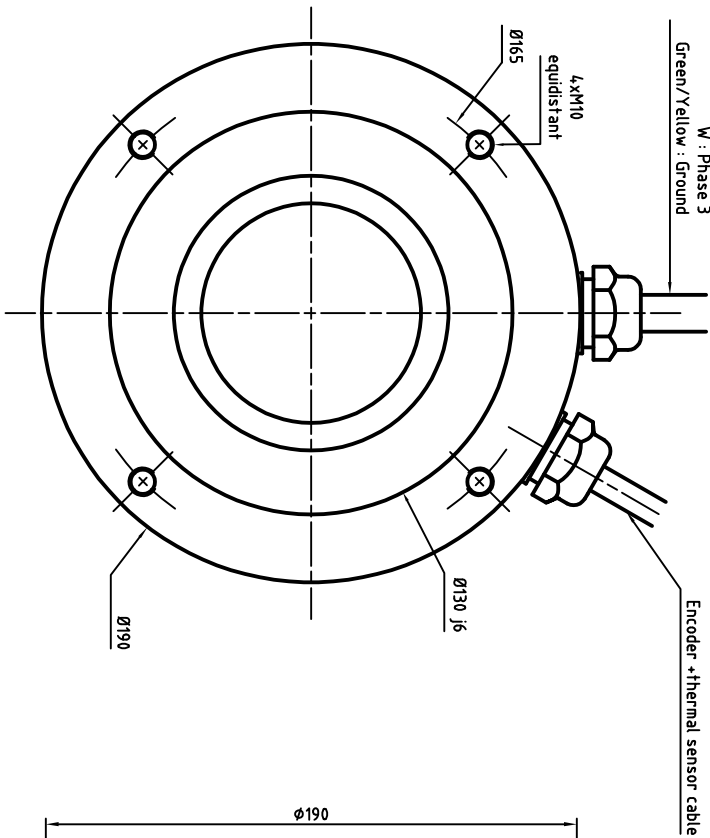

ENCODER SIGNAL COLORS

Cable information	ERN1387 (4)	ERN1381 (5)	ECN1313 (8)	EQN1325 (9)	ECN1325 (C)	EQN1337 (D)
White	A+	0V	Up	Up	CLOCK+	CLOCK+
Brown	A-	Up	0V	0V	CLOCK-	CLOCK-
Green	R+	A+	A+	A+	DATA+	DATA+
Yellow	R-	A-	A-	A-	DATA-	DATA-
Pink	D+	B-	B-	B-	PTC	PTC
Grey	D-	B+	B+	B+	PTC	PTC
Blue	C+	R+	DATA+	DATA+	0V	0V
Red	C-	R-	DATA-	DATA-	Up	Up
Black	PTC	PTC	CLOCK+	CLOCK+	KTY84	KTY84
Violet	PTC	PTC	CLOCK-	CLOCK-	KTY84	KTY84
Grey/Pink	B+	KTY84	PTC	PTC	N/A	N/A
Red/Blue	B-	KTY84	PTC	PTC	N/A	N/A
White/Green	0V	N/A	KTY84	KTY84	N/A	N/A
Brown/Green	Up	N/A	KTY84	KTY84	N/A	N/A
White/Yellow	KTY84	N/A	N/A	N/A	N/A	N/A
Brown/Yellow	KTY84	N/A	N/A	N/A	N/A	N/A

Wires colors

ALXION

AUTOMATIQUE & PRODUCTIQUE
 Parc Technologique des Fossés Jean
 92712 COLOMBES Cedex
 Tél: 014.1306304 - Fax: 014.1306136

190S T2M16[4-5-8-9-C-D]BXXXXX