

Power cable  
diameter and section  
depends on rated current  
U : Phase 1  
V : Phase 2  
W : Phase 3  
Green/Yellow : Ground

Resolver + thermal sensors cable  
Sinus + (S2) : Green  
Sinus - (S4) : Yellow  
Cosinus + (S1) : White  
Cosinus - (S3) : Brown  
Input carrier + (R1) : Red  
Input carrier - (R3) : Blue  
PTC : Grey  
KTY84 : Black  
KTY84 : Violet

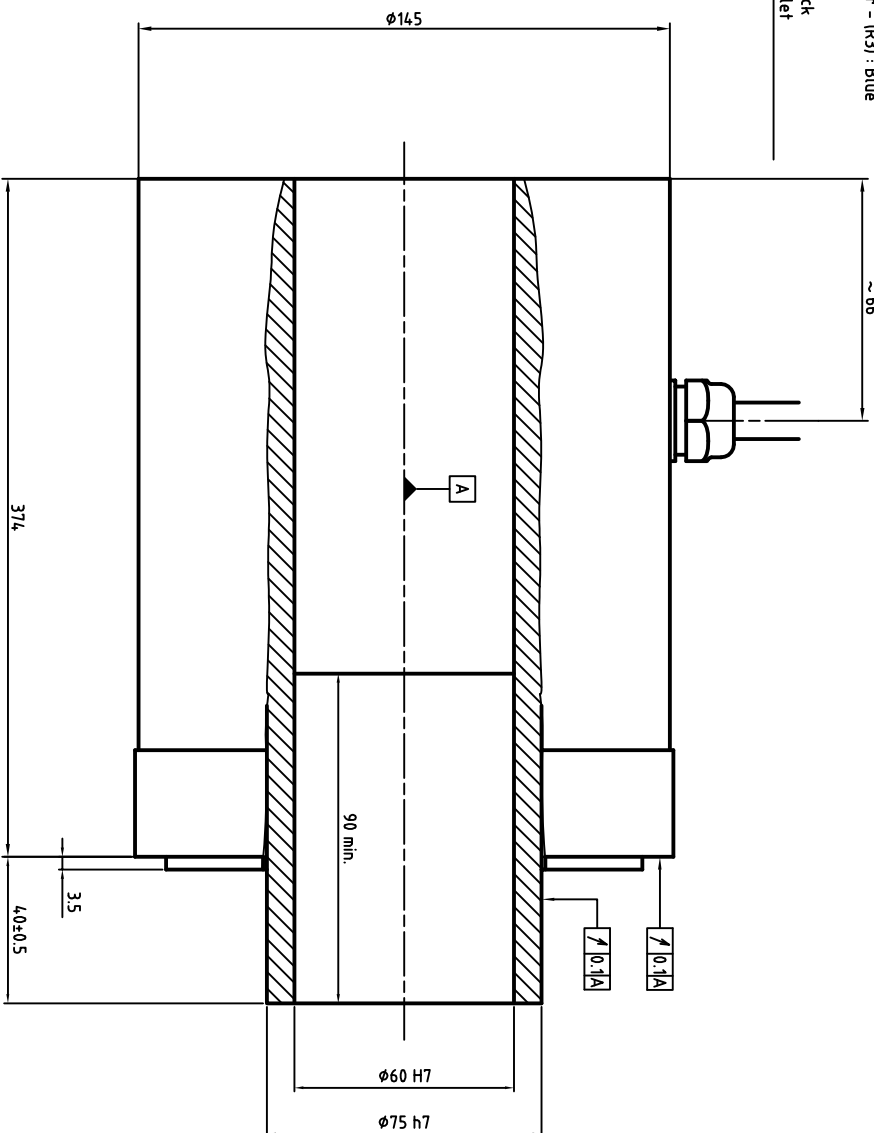

**ALXION**

AUTOMATIQUE & PRODUCTIQUE  
Parc Technologique des Fossés Jean  
92712 COLONBES Cedex  
Tél: 0141306304 - Fax: 0141306136

145S T8M271BXXXX